

Installation Instruction

OPA 96506520

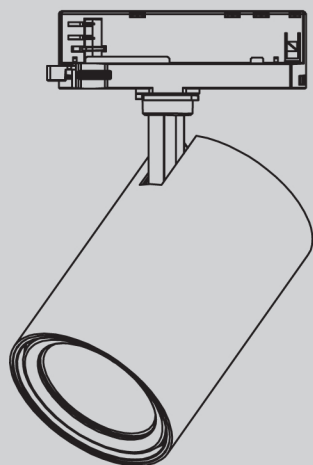

CAUTIONS

1. Switch – off the power supply before any installation and maintenance operations.
2. Installation should be carried out by a suitably qualified person in accordance with good electrical practice and the appropriate national wiring regulations.
3. The ambient temperature (TA) $\leq 30^{\circ}\text{C}$, stop using out of the ambient temperature.
4. Don't change the ambient application of lighting, if the lighting IP rate is not high, please don't install the lighting in the bathroom and outdoor.
5. Do not change the usage of lighting, regular indoor lighting, the lighting optic is downward or wallwasher, don't allow upward.
6. Do not change the original structure design of the lighting, such as add or remove some parts, honeycomb etc.
7. Don't use any material to cover the recessed lighting (down light or surface light) when it working (except the IC type of US or European standard), otherwise the lifespan will be affected.
8. Make sure the luminaries working under the rated voltage which the manual or the driver marked.
9. Please do not use this lighting during the decoration, to avoid the lighting damage by the surging voltage generation of the machine and equipments on site.
10. Start to install the lighting when the paint of ceiling surface is cured, to avoid the corrosion of fixture by the organic solvents paint, Stop to paint after the fixture installation.
11. The cutout hole size of brochure only for reference, please cutout it according to the actual product.
12. To avoid damage the terminal of driver, the size and length of input cable should be comply with the standard requirement which mark on the driver.

ANGLE ADJUSTMENT

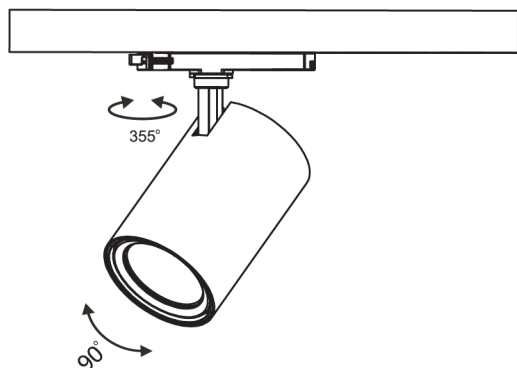

LAMP INSTALLATION

1

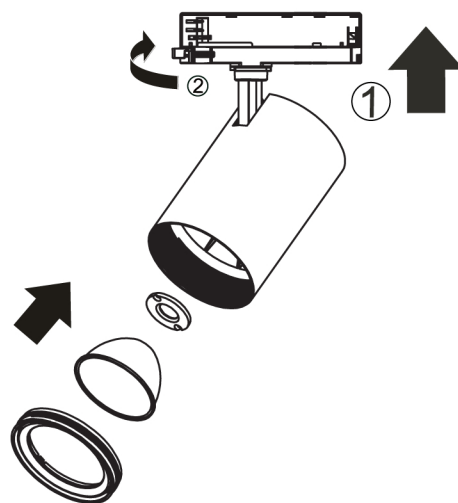

2

4-PHASE TRACK INSTALL (PK)

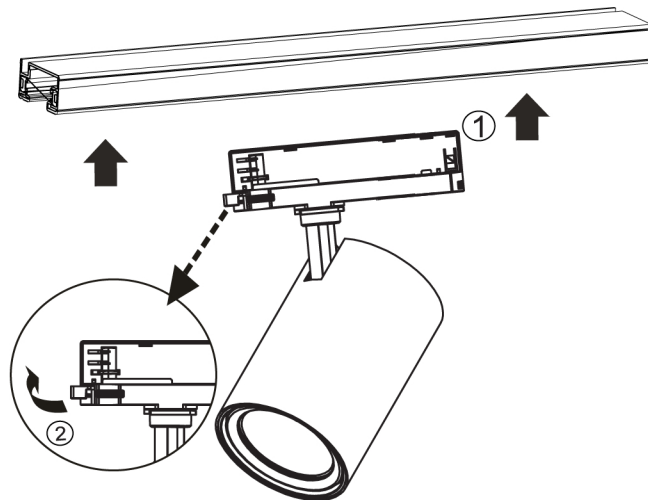

MEASUREMENT

Dimension in mm

